



Cantidad de artículos por referencia *number of items per reference* : 1ud

Recomendaciones para el desembalaje: Vigilar al abrir con un elemento afilado el embalaje. Guardar el embalaje unos días para en caso de devolución y mantener las instrucciones de montaje para posibles consultas

Recommendations for unpacking: *Be careful when opening the packaging with a sharp object. Keep the packaging for a few days in case of return and keep the assembly instructions for future reference.*

Sugerencias de montaje: . Sólo las patas tienen que ser montadas. Comprobar y clasificar todos los herrajes antes de comenzar el montaje. Montar sobre una superficie blanda

Assembly tips: *Only the legs need to be assembled. Check and sort all fittings before starting assembly. Mount on a soft surface*

EMBALAJE | PACKAGING

Tipo	uds/caja	ancho	fondo	alto	volumen	P. N	P.B.
Type	s/carton	length	width	height	volumen	N.W	G.W
Caja 1	1	124	63	25	0,20	32,10	35,00

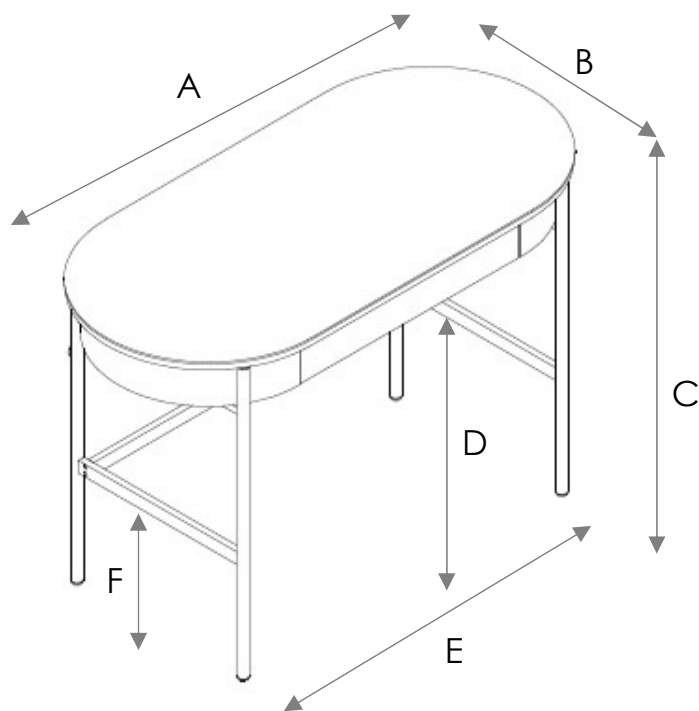

DIMENSIONES
MEASUREMENTS
117x56x76cm

ancho x fondo x alto
length x width x height

A	117	cm
B	56	cm
C	76	cm
D	64	cm
E	84	cm
F	31	cm

PIEZAS PIECES

1_1UD
Cuerpo con cajón
Body with drawer

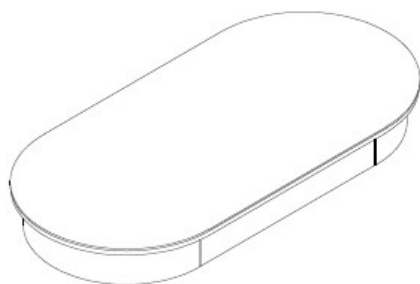

2_1UD
Patas metálicas
Metal legs

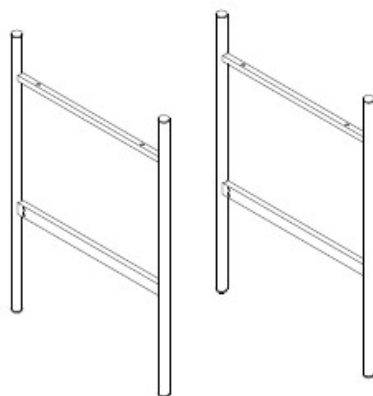

3_2UD
Anclajes
Anchorage



M6x25 | 8UD



M6x14 | 4UD



5mm | 1UD



1UD



MONTAJE ASSEMBLY

Paso 1 Step 1 M6x25 | 4UD 

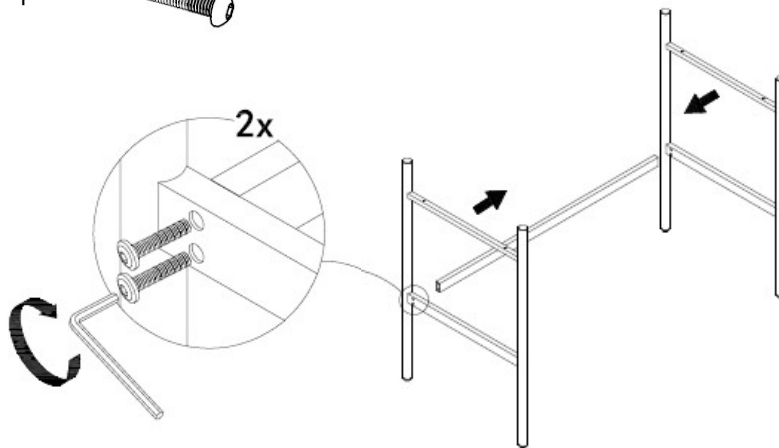

Paso 2 Step 2 M6x25 | 4UD M6x14 | 4D

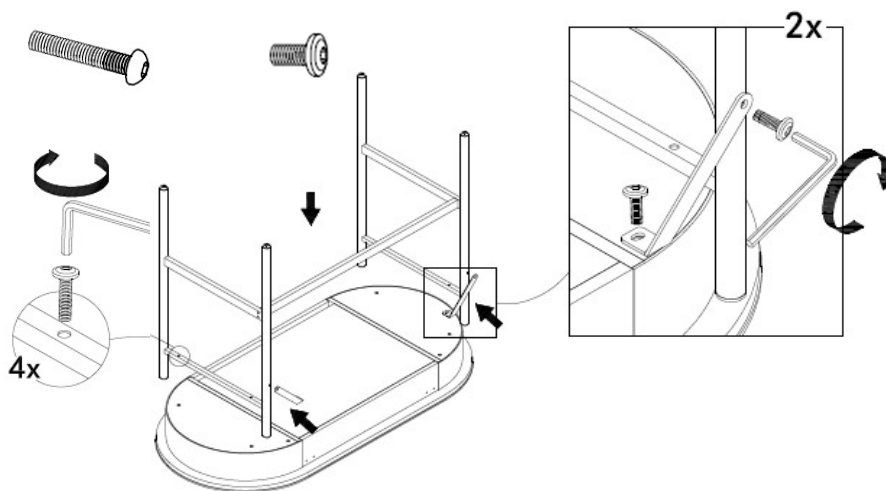

Paso 3 Step 3

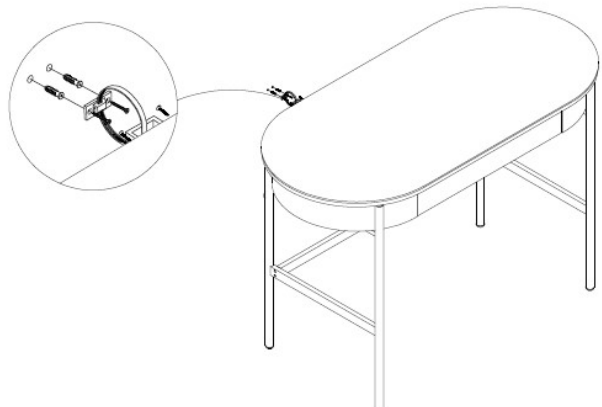

Paso 4 Step 4

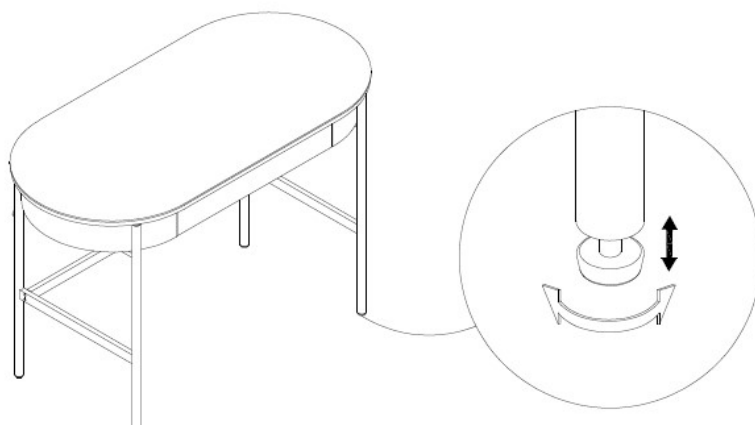

MONTAJE ASSEMBLY

Ajustar el cajón *Adjustment for drawer face gaps*

Paso 1 *Step 1*

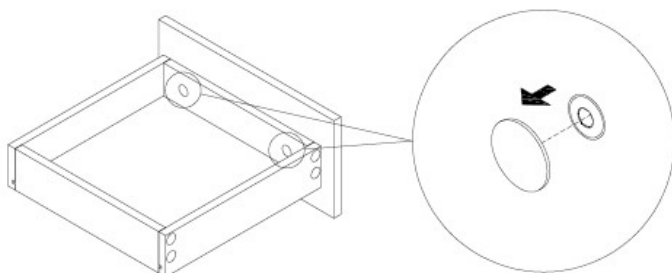

Paso 2 *Step 2*

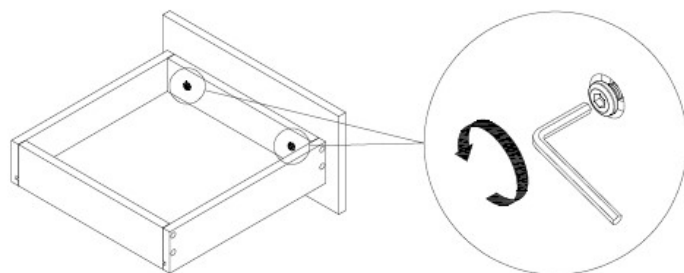

Paso 3 *Step 3*

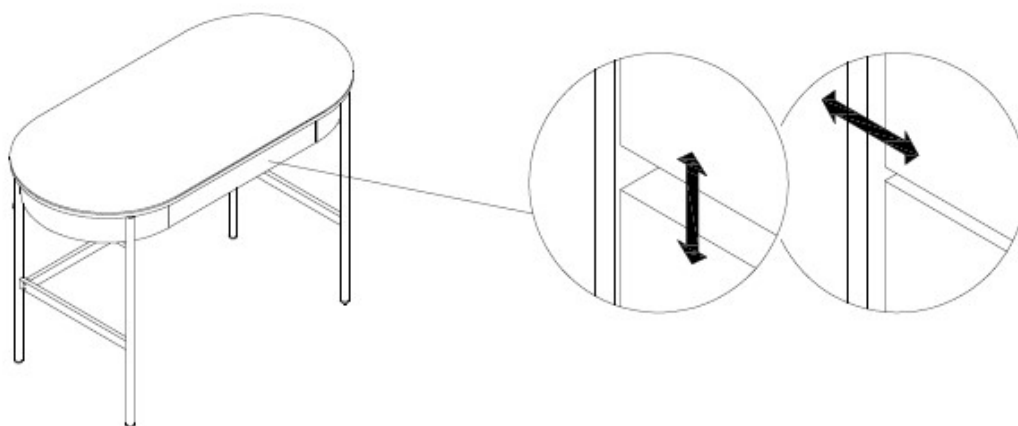

Paso 4 *Step 4*

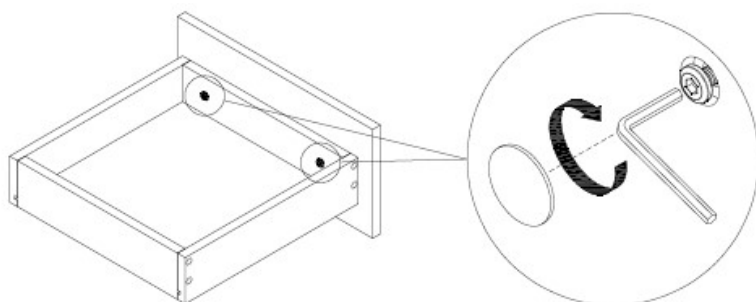

INSTRUCCIONES DE LIMPIEZA PRODUCT CARE

1. NO USAR NUNCA PRODUCTOS QUÍMICOS NI ABRASIVOS QUE PUEDAN DAÑAR EL ARTÍCULO.
2. LIMPIAR SIEMPRE CON PAÑO SECO Y LIMPIO.
3. LA LUZ SOLAR DIRECTA PUEDE DAÑAR EL ARTÍCULO.
4. SITÚE SIEMPRE SU MOBILIARIO A UNA DISTANCIA NO INFERIOR A 70 CM DE UNA FUENTE DIRECTA DE CALOR, TALES COMO CHIMENEAS, RADIADORES, ETC.

1. NEVER USE HOUSEHOLD CLEANERS, CLEANING SOLUTIONS OR HARSH CHEMICALS TO CLEAN THE FURNITURE.
2. CLEAN WITH A DRY AND SOFT CLOTH
3. DIRECT SUNLIGHT CAN BE HARMFUL TO THIS FURNITURE. YOU MUST AVOID EXPOSURE TO DIRECT SUNLIGHT
4. ALWAYS PLACE THE FURNITURE AT LEAST 70CM AWAY FROM ANY DIRECT SOURCE OF HEAT, SUCH AS FIREPLACES, RADIATORS, ETC.